

# SL3-150 Application Guide

## Line Side of the Main Breaker

### Direct Bus Connection

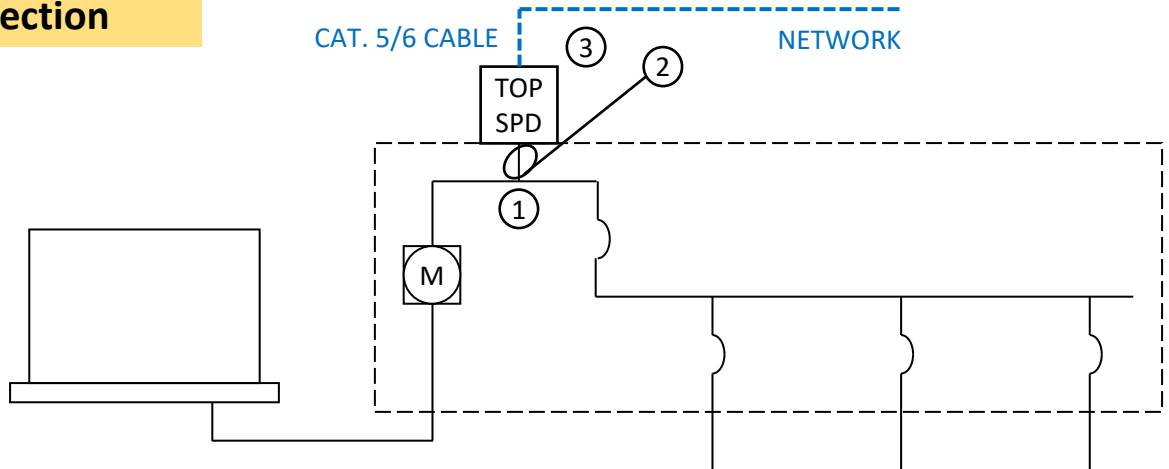

#### SHEET NOTES

- ① SWITCHGEAR MANUFACTURER TO INSTALL #2 AWG TAP LUGS.
- ② PHASE, NEUTRAL AND GROUND CONDUCTORS SHALL BE #2 AWG.
- ③ EXTERNALLY MOUNTED TEMPORARY OVERVOLTAGE PROTECTION SPD. UL 1449 LISTED. NEMA 4/12 WITH INTEGRAL DISCONNECT. SINGLE-PULSE SURGE CURRENT CAPACITY: 150 KA/MODE, TO BE A TESTED VALUE. 20 YEAR WARRANTY. NETWORK-ACCESSIBLE POWER QUALITY & PERFORMANCE MONITORING. WITH COMMISSIONING AND INSTALLED TESTING WITH PORTABLE SURGE GENERATOR-TEST SET. SUBMIT REPORT WITH LET-THRU VOLTAGES TO THE ENGINEER. CURRENT TECHNOLOGY SL3-150 SERIES.

The product number is given on the previous page for the system configurations shown, with an integral disconnect switch and the M4 monitoring system. For other configurations and options for the SL3-150, see the "Product Number Configuration Guide" and the "Monitoring System Selection Guide".